

CONTROL KNOBS, MACHINED ALUMINUM

FEATURES

- Anodized natural or black gloss finish.
- Anti-static plastic insert. (on many models)
- Positive retention #6-32 set screws.
- Fits 1/8" dia. & 1/4" dia. shafts.
- Functionally rugged.
- Special designs available.

MATERIALS

Knob:
Threaded Insert:
Setscrew:

Machined aluminium (with plastic insert, where indicated).
Brass.
Heat treated high alloy steel with cup point and hex head,
or slotted head. Note: 1 or 2 supplied, depending on model.

Notes: Dims. in inches & (millimeters). Shaft size is last 3 digits of Model No.

41005 SERIES Smooth finish with knurled black plastic insert and black indicator line on top

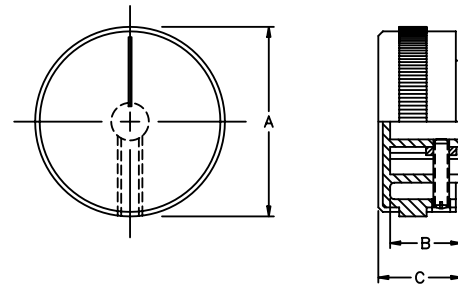

Note: Knob color is natural only for this Series.

| MODEL (Color natural) | A | B | C |
|-----------------------|--------------|-------------|-------------|
| 41005A1/8 | .630 (16.0) | .512 (13.0) | .590 (15.0) |
| 41005A1/4 | .630 (16.0) | .512 (13.0) | .590 (15.0) |
| 410053A1/8 | .874 (22.2) | .472 (12.0) | .531 (13.5) |
| 410053A1/4 | .874 (22.2) | .646 (16.4) | .690 (17.5) |
| 410055A1/4 | 1.260 (32.0) | .472 (12.0) | .551 (14.0) |

42001 SERIES Fluted with plastic insert and line indicator on side

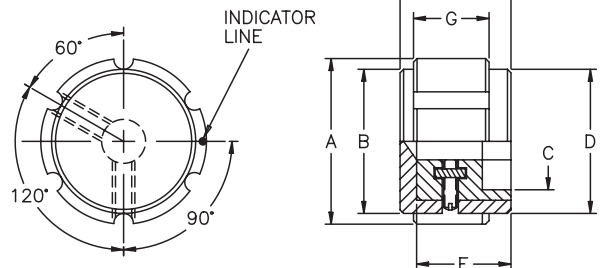

| MODEL (Color-natural) | MODEL (Color-black) | A | B | C | D | E | F | G |
|-----------------------|---------------------|-------------|-------------|-------------|-------------|-------------|-------------|-------------|
| 42001A1/8* | 42001B1/8* | .500 (12.7) | .430 (10.9) | .380 (9.7) | .430 (10.9) | .630 (16.0) | .512 (13.0) | .430 (10.9) |
| 42001A1/4* | 42001B1/4* | .500 (12.7) | .430 (10.9) | .380 (9.7) | .430 (10.9) | .630 (16.0) | .512 (13.0) | .430 (10.9) |
| 420013A1/4 | 420013B1/4 | .748 (19.0) | .638 (16.2) | .591 (15.0) | .661 (16.8) | .630 (16.0) | .512 (13.0) | .429 (10.9) |
| 420015A1/4 | 420015B1/4 | .941 (23.9) | .819 (20.8) | .709 (18.0) | .819 (20.8) | .630 (16.0) | .512 (13.0) | .429 (10.9) |

* indicates solid aluminum knob

42003 SERIES Diamond knurl plastic insert and line indicator on side

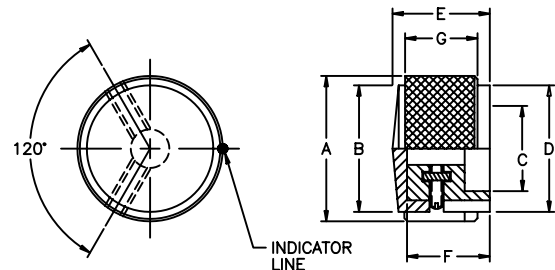

Note: 42003A1/8 & 42003A1/4 have only one set screw.

| MODEL (Color-natural) | MODEL (Color-black) | A | B | C | D | E | F | G |
|-----------------------|---------------------|--------------|--------------|-------------|--------------|-------------|-------------|-------------|
| 42003A1/8* | 42003B1/8* | .500 (12.7) | .402 (10.2) | .380 (9.7) | .402 (10.2) | .634 (16.1) | .516 (13.1) | .469 (11.9) |
| 42003A1/4* | 42003B1/4* | .500 (12.7) | .402 (10.2) | .380 (9.7) | .402 (10.2) | .634 (16.1) | .516 (13.1) | .469 (11.9) |
| 420033A1/4* | 420033B1/4* | .748 (19.0) | .681 (17.3) | .591 (15.0) | .681 (17.3) | .634 (16.1) | .516 (13.1) | .469 (11.9) |
| 420035A1/4* | 420035B1/4* | .940 (23.9) | .870 (22.1) | .709 (18.0) | .870 (22.1) | .634 (16.1) | .516 (13.1) | .469 (11.9) |
| 420037A1/4* | 420037B1/4* | 1.252 (31.8) | 1.170 (29.6) | .980 (24.9) | 1.170 (29.6) | .748 (19.0) | .630 (16.0) | .591 (15.0) |

* indicates solid aluminum knob

SPECIFICATIONS SUBJECT TO CHANGE WITHOUT NOTICE.

Notes: Dims. in inches & (millimeters). Shaft size is last 3 digits of Model No.

42004 SERIES Straight knurl with plastic insert and line indicator on top

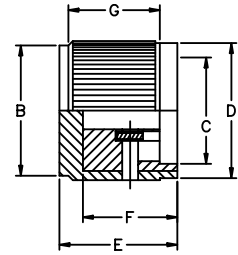
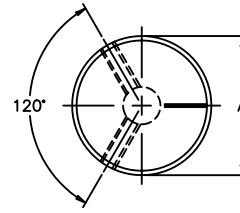

Note: 420041A1/8 & 420041A1/4 have only one set screw.

| MODEL (Color-natural) | MODEL (Color-black) | A | B | C | D | E | F | G |
|-----------------------|---------------------|-------------|-------------|-------------|-------------|-----------|-------------|-------------|
| 420041A1/8* | 420041B1/8* | .500 (12.7) | .480 (12.2) | .378 (9.6) | .480 (12.2) | .788 (20) | .520 (13.2) | .453 (11.5) |
| 420041A1/4* | 420041B1/4* | .500 (12.7) | .480 (12.2) | .378 (9.6) | .480 (12.2) | .788 (20) | .520 (13.2) | .453 (11.5) |
| 420043A1/4 | 420043B1/4 | .748 (19.0) | .728 (18.5) | .524 (13.3) | .728 (18.5) | .788 (20) | .520 (13.2) | .453 (11.5) |
| 420045A1/4 | 420045B1/4 | .929 (23.6) | .870 (22.1) | .720 (18.3) | .870 (22.1) | .788 (20) | .520 (13.2) | .453 (11.5) |

* indicates solid aluminum knob

42005 SERIES Solid aluminum with straight knurl and arrowhead indicator on top

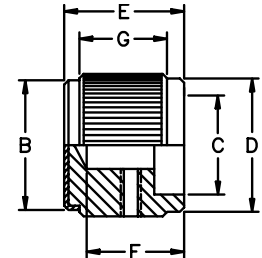
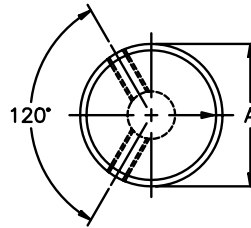

Note: 420051A1/8 & 420051A1/4 have only one set screw.

| MODEL (Color-natural) | MODEL (Color-black) | A | B | C | D | E | F | G |
|-----------------------|---------------------|-------------|-------------|-------------|-------------|-------------|-------------|-------------|
| 420051A1/8* | 420051B1/8* | .500 (12.7) | .480 (12.2) | .378 (9.6) | .480 (12.2) | .638 (16.2) | .520 (13.2) | .453 (11.5) |
| 420051A1/4* | 420051B1/4* | .500 (12.7) | .480 (12.2) | .378 (9.6) | .480 (12.2) | .638 (16.2) | .520 (13.2) | .453 (11.5) |
| 420053A1/4 | 420053B1/4 | .748 (19.0) | .728 (18.5) | .524 (13.3) | .728 (18.5) | .638 (16.2) | .520 (13.2) | .453 (11.5) |
| 420055A1/4 | 420055B1/4 | .929 (23.6) | .870 (23.2) | .720 (18.3) | .870 (23.2) | .638 (16.2) | .520 (13.2) | .453 (11.5) |

* indicates solid aluminum knob

42006 SERIES Straight knurl with plastic insert and line indicator on top and side

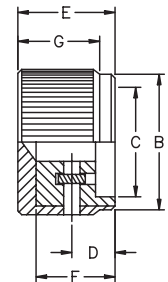
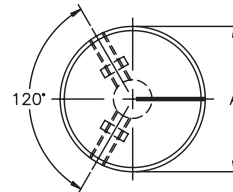

Note: 420061A1/8 & 420061A1/4 have only one set screw.

| MODEL (Color-natural) | MODEL (Color-black) | A | B | C | D | E | F | G |
|-----------------------|---------------------|--------------|--------------|--------------|------------|-------------|-------------|-------------|
| 420061A1/8* | 420061B1/8* | .500 (12.7) | .480 (12.2) | .378 (9.6) | .280 (7.1) | .638 (16.2) | .520 (13.2) | .524 (13.3) |
| 420061A1/4* | 420061B1/4* | .500 (12.7) | .480 (12.2) | .378 (9.6) | .280 (7.1) | .638 (16.2) | .520 (13.2) | .524 (13.3) |
| 420063A1/4 | 420063B1/4 | .748 (19.0) | .728 (18.5) | .524 (13.3) | .280 (7.1) | .638 (16.2) | .520 (13.2) | .524 (13.3) |
| 420065A1/4 | 420065B1/4 | .940 (23.9) | .870 (23.2) | .720 (18.3) | .280 (7.1) | .638 (16.2) | .520 (13.2) | .524 (13.3) |
| 420067A1/4 | 420067B1/4 | 1.248 (31.7) | 1.220 (31.0) | 1.030 (26.2) | .280 (7.1) | .638 (16.2) | .512 (13.0) | .531 (13.5) |

* indicates solid aluminum knob

42007 SERIES Serrated diamond trim with plastic insert and dot indicator on top

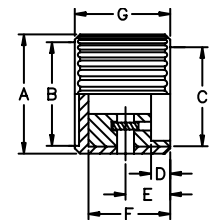
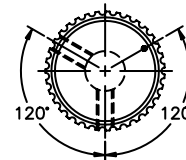

Note: 420071A1/8 & 420072A1/8 have only one set screw.

* indicates solid aluminum knob

| MODEL (Color-natural) | MODEL (Color-black) | A | B | C | D | E | F | G |
|-----------------------|---------------------|-------------|-------------|-------------|------------|------------|-------------|-------------|
| 420071A1/8* | 420071B1/8* | .370 (9.4) | .268 (6.8) | .276 (7.0) | .091 (2.3) | .200 (5.1) | .240 (6.1) | .300 (7.6) |
| 420072A1/8* | 420072B1/8* | .370 (9.4) | .268 (6.8) | .276 (7.0) | .091 (2.3) | .200 (5.1) | .358 (9.1) | .449 (11.4) |
| 420072A1/4* | 420072B1/4* | .370 (9.4) | .268 (6.8) | .276 (7.0) | .091 (2.3) | .200 (5.1) | .358 (9.1) | .449 (11.4) |
| 420073A1/8* | 420073B1/8* | .492 (12.5) | .386 (9.8) | .380 (9.7) | .120 (3.1) | .280 (7.1) | .512 (13.0) | .598 (15.2) |
| 420073A1/4* | 420073B1/4* | .492 (12.5) | .386 (9.8) | .380 (9.7) | .120 (3.1) | .280 (7.1) | .512 (13.0) | .598 (15.2) |
| 420074A1/4 | 420074B1/4 | .748 (19.0) | .650 (16.5) | .587 (14.9) | .120 (3.1) | .280 (7.1) | .512 (13.0) | .598 (15.2) |

* indicates solid aluminum knob

SPECIFICATIONS SUBJECT TO CHANGE WITHOUT NOTICE.

Notes: Dims. in inches & (millimeters). Shaft size is last 3 digits of Model No.

42008 SERIES Square serrations with plastic insert and line indicator on side

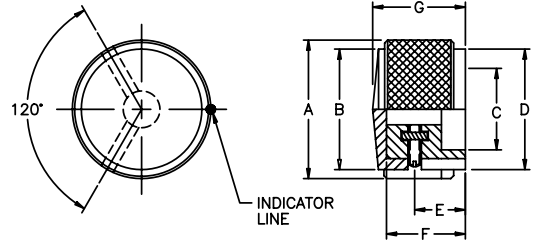

Note: 420081A1/8 & 420081A1/4 have only one set screw.

| MODEL (Color-natural) | MODEL (Color-black) | A | B | C | D | E | F | G |
|-----------------------|---------------------|--------------|--------------|-------------|--------------|------------|-------------|-------------|
| 420081A1/8* | 420081B1/8* | .500 (12.7) | .402 (10.2) | .380 (9.7) | .402 (10.2) | .280 (7.1) | .512 (13.0) | .630 (16.0) |
| 420081A1/4* | 420081B1/4* | .500 (12.7) | .402 (10.2) | .380 (9.7) | .402 (10.2) | .280 (7.1) | .512 (13.0) | .630 (16.0) |
| 420083A1/4 | 420083B1/4 | .748 (19.0) | .681 (17.3) | .587 (14.9) | .681 (17.3) | .280 (7.1) | .512 (13.0) | .630 (16.0) |
| 420085A1/4 | 420085B1/4 | .940 (23.9) | .870 (22.1) | .709 (18.0) | .870 (22.1) | .280 (7.1) | .512 (13.0) | .630 (16.0) |
| 420087A1/4 | 420087B1/4 | 1.248 (31.7) | 1.165 (29.6) | .985 (25) | 1.165 (29.6) | .280 (7.1) | .630 (16.0) | .630 (16.0) |

* indicates solid aluminum knob

42009 SERIES Straight knurl with plastic insert and line indicator on top and chamfer around top

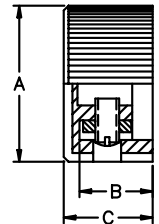
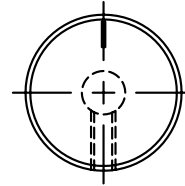
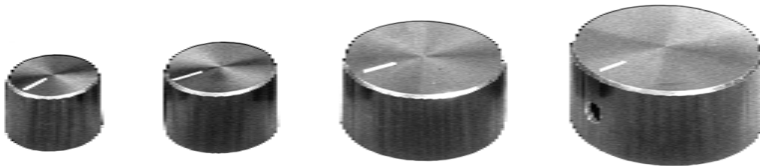

Note: Knob color is black only for this Series.

| MODEL (Color black) | A | B | C |
|---------------------|--------------|-------------|-------------|
| 420091B1/8 | .732 (18.6) | .374 (9.5) | .472 (12.0) |
| 420091B1/4 | .732 (18.6) | .374 (9.5) | .472 (12.0) |
| 420092B1/4 | .898 (22.8) | .433 (11.0) | .512 (13.0) |
| 420093B1/4 | 1.280 (32.5) | .492 (12.5) | .551 (14.0) |
| 420094B1/4 | 1.512 (38.4) | .531 (13.5) | .630 (16.0) |

* indicates solid aluminum knob

42011 SERIES Smooth finish with plastic insert and line indicator on top

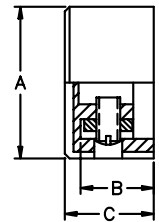
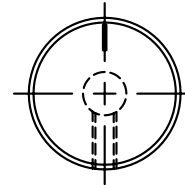

| MODEL (Color-natural) | MODEL (Color-black) | A | B | C |
|-----------------------|---------------------|--------------|-------------|-------------|
| 420111A1/8 | 420111B1/8 | .709 (18.0) | .374 (9.5) | .472 (12.0) |
| 420111A1/4 | 420111B1/4 | .709 (18.0) | .374 (9.5) | .472 (12.0) |
| 420112A1/4 | 420112B1/4 | .874 (22.2) | .433 (11.0) | .512 (13.0) |
| 420113A1/4 | 420113B1/4 | 1.255 (31.9) | .492 (12.5) | .551 (14.0) |
| 420114A1/4 | 420114B1/4 | 1.488 (37.8) | .531 (13.5) | .630 (16.0) |

* indicates solid aluminum knob

42012 SERIES Straight knurl with plastic insert and line indicator on top

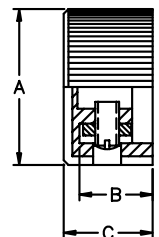
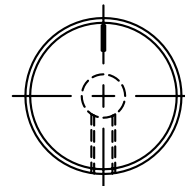

| MODEL (Color-natural) | A | B | C |
|-----------------------|--------------|-------------|-------------|
| 420121A1/8 | .732 (18.6) | .374 (9.5) | .472 (12.0) |
| 420121A1/4 | .732 (18.6) | .374 (9.5) | .472 (12.0) |
| 420122A1/4 | .898 (22.8) | .433 (11.0) | .512 (13.0) |
| 420123A1/4 | 1.280 (32.5) | .492 (12.5) | .551 (14.0) |
| 420124A1/4 | 1.512 (38.4) | .531 (13.5) | .630 (16.0) |

* indicates solid aluminum knob

SPECIFICATIONS SUBJECT TO CHANGE WITHOUT NOTICE.



Notes: Dims. in inches & (millimeters). Shaft size is last 3 digits of Model No.

KB SERIES Solid aluminum with straight knurl and line indicator on top

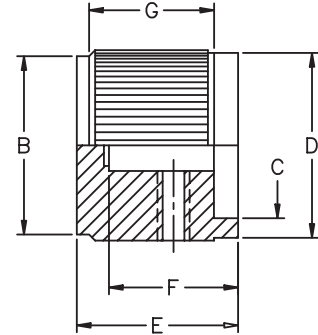
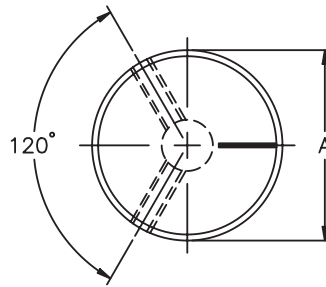

| MODEL | COLOR | A | B | C | D | E | F | G |
|---------------------------|-------------|-------------|-------------|-------------|-------------|-------------|-------------|-------------|
| KB500A1/8AL | Natural | .500 (12.7) | .430 (10.9) | .390 (9.90) | .470 (11.9) | .790 (20.0) | .630 (16.0) | .610 (15.5) |
| KB500A1/4AL | Natural | .500 (12.7) | .430 (10.9) | .390 (9.90) | .470 (11.9) | .790 (20.0) | .630 (16.0) | .610 (15.5) |
| KB500B1/8AL | Black | .500 (12.7) | .430 (10.9) | .390 (9.90) | .470 (11.9) | .790 (20.0) | .630 (16.0) | .610 (15.5) |
| KB500B1/4AL | Black | .500 (12.7) | .430 (10.9) | .390 (9.90) | .470 (11.9) | .790 (20.0) | .630 (16.0) | .610 (15.5) |
| KB700A1/4AL | Natural | .750 (19.0) | .680 (17.3) | .590 (15.0) | .710 (18.0) | .790 (20.0) | .630 (16.0) | .610 (15.5) |
| KB700B1/4AL | Black | .750 (19.0) | .680 (17.3) | .590 (15.0) | .710 (18.0) | .790 (20.0) | .630 (16.0) | .610 (15.5) |
| KB900A1/4AL | Natural | .930 (23.6) | .870 (22.1) | .710 (18.0) | .900 (22.9) | .790 (20.0) | .630 (16.0) | .610 (15.5) |
| KB900B1/4AL | Black | .930 (23.6) | .870 (22.1) | .710 (18.0) | .900 (22.9) | .790 (20.0) | .630 (16.0) | .610 (15.5) |
| TWO-TONED BODY-TOP | | | | | | | | |
| KB500AB1/8AL | NTL. & BLK. | .500 (12.7) | .430 (10.9) | .390 (9.90) | .470 (11.9) | .790 (20.0) | .630 (16.0) | .610 (15.5) |
| KB500AB1/4AL | NTL. & BLK. | .500 (12.7) | .430 (10.9) | .390 (9.90) | .470 (11.9) | .790 (20.0) | .630 (16.0) | .610 (15.5) |
| KB500BA1/8AL | BLK. & NTL. | .500 (12.7) | .430 (10.9) | .390 (9.90) | .470 (11.9) | .790 (20.0) | .630 (16.0) | .610 (15.5) |
| KB500BA1/4AL | BLK. & NTL. | .500 (12.7) | .430 (10.9) | .390 (9.90) | .470 (11.9) | .790 (20.0) | .630 (16.0) | .610 (15.5) |
| KB700AB1/4AL | NTL. & BLK. | .750 (19.0) | .680 (17.3) | .590 (15.0) | .710 (18.0) | .790 (20.0) | .630 (16.0) | .610 (15.5) |
| KB700BA1/4AL | BLK. & NTL. | .750 (19.0) | .680 (17.3) | .590 (15.0) | .710 (18.0) | .790 (20.0) | .630 (16.0) | .610 (15.5) |
| KB900AB1/4AL | NTL. & BLK. | .930 (23.6) | .870 (22.1) | .710 (18.0) | .900 (22.9) | .790 (20.0) | .630 (16.0) | .610 (15.5) |
| KB900BA1/4AL | BLK. & NTL. | .930 (23.6) | .870 (22.1) | .710 (18.0) | .900 (22.9) | .790 (20.0) | .630 (16.0) | .610 (15.5) |

KHF SERIES Solid aluminum with smooth finish and sawcut indicator on top and side

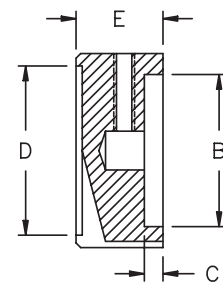
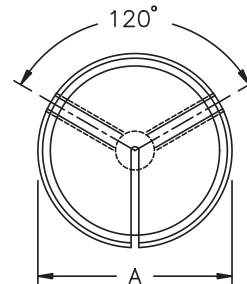

| MODEL (Color-natural) | A | B | C | D | E |
|-----------------------|-------------|--------------|-------------|-------------|-------------|
| KHF500A1/4 | .500 (12.7) | .380 (9.65) | .120 (3.05) | .340 (8.64) | .560 (14.2) |
| KHF700A1/4 | .750 (19.0) | .590 (14.90) | .120 (3.05) | .580 (14.7) | .560 (14.2) |
| KHF900A1/4 | .940 (23.9) | .710 (18.0) | .120 (3.05) | .780 (19.8) | .560 (14.2) |
| KHF1250A1/4 | 1.25 (31.8) | .980 (24.9) | .120 (3.05) | 1.09 (27.7) | .560 (14.2) |

KN SERIES Solid aluminum with straight knurl and arrowhead indicator on top

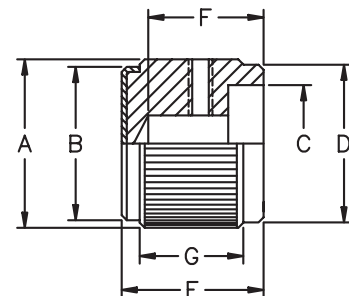
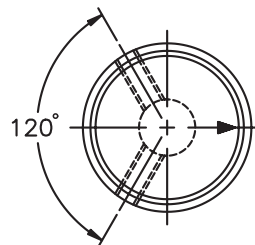

| MODEL (Two-toned) | COLOR (Body-top) | A | B | C | D | E | F | G |
|-------------------|------------------|-------------|-------------|-------------|-------------|-------------|-------------|-------------|
| KN501BA1/8 | Blk. & Natural | .500 (12.7) | .450 (11.4) | .380 (9.65) | .450 (11.4) | .630 (16.0) | .510 (13.0) | .460 (11.7) |
| KN501BA1/4 | Blk. & Natural | .500 (12.7) | .450 (11.4) | .380 (9.65) | .450 (11.4) | .630 (16.0) | .510 (13.0) | .460 (11.7) |
| KN701BA1/8 | Blk. & Natural | .750 (19.0) | .680 (17.3) | .590 (15.0) | .700 (17.8) | .630 (16.0) | .510 (13.0) | .460 (11.7) |
| KN701BA1/4 | Blk. & Natural | .750 (19.0) | .680 (17.3) | .590 (15.0) | .700 (17.8) | .630 (16.0) | .510 (13.0) | .460 (11.7) |

SPECIFICATIONS SUBJECT TO CHANGE WITHOUT NOTICE.

Notes: Dims. in inches & (millimeters). Shaft size is last 3 digits of Model No.

KN SERIES Solid aluminum with straight knurl and line indicator on side

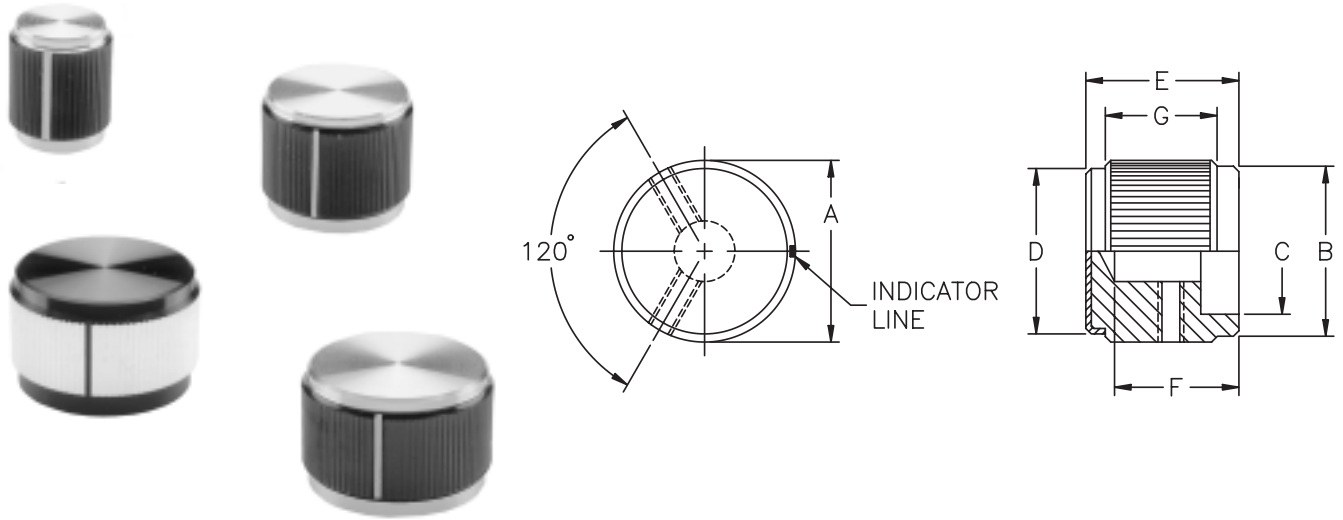

SPECIFICATIONS SUBJECT TO CHANGE WITHOUT NOTICE.

| MODEL (Two-toned) | COLOR (Body-top) | A | B | C | D | E | F | G |
|-------------------|------------------|-------------|-------------|-------------|-------------|-------------|-------------|-------------|
| KN500AB1/8 | Natural & Blk. | .500 (12.7) | .450 (11.4) | .380 (9.65) | .450 (11.4) | .630 (16.0) | .510 (13.0) | .460 (11.7) |
| KN500AB1/4 | Natural & Blk. | .500 (12.7) | .450 (11.4) | .380 (9.65) | .450 (11.4) | .630 (16.0) | .510 (13.0) | .460 (11.7) |
| KN500BA1/8 | Blk. & Natural | .500 (12.7) | .450 (11.4) | .380 (9.65) | .450 (11.4) | .630 (16.0) | .510 (13.0) | .460 (11.7) |
| KN500BA1/4 | Blk. & Natural | .500 (12.7) | .450 (11.4) | .380 (9.65) | .450 (11.4) | .630 (16.0) | .510 (13.0) | .460 (11.7) |
| KN700AB1/4 | Natural & Blk. | .750 (19.0) | .700 (17.8) | .590 (14.9) | .700 (17.8) | .630 (16.0) | .510 (13.0) | .460 (11.7) |
| KN700BA1/4 | Blk. & Natural | .750 (19.0) | .700 (17.8) | .590 (14.9) | .700 (17.8) | .630 (16.0) | .510 (13.0) | .460 (11.7) |
| KN900AB1/4 | Natural & Blk. | .940 (23.9) | .880 (22.3) | .710 (18.0) | .800 (22.3) | .630 (16.0) | .510 (13.0) | .460 (11.7) |
| KN900BA1/4 | Blk. & Natural | .940 (23.9) | .880 (22.3) | .710 (18.0) | .800 (22.3) | .630 (16.0) | .510 (13.0) | .460 (11.7) |
| KN1250AB1/4 | Natural & Blk. | 1.25 (31.7) | 1.20 (30.5) | .980 (24.9) | 1.20 (30.5) | .630 (16.0) | .510 (13.0) | .460 (11.7) |
| KN1250BA1/4 | Blk. & Natural | 1.25 (31.7) | 1.20 (30.5) | .980 (24.9) | 1.20 (30.5) | .630 (16.0) | .510 (13.0) | .460 (11.7) |

KNS SERIES Solid aluminum with straight knurl and arrowhead indicator on skirt

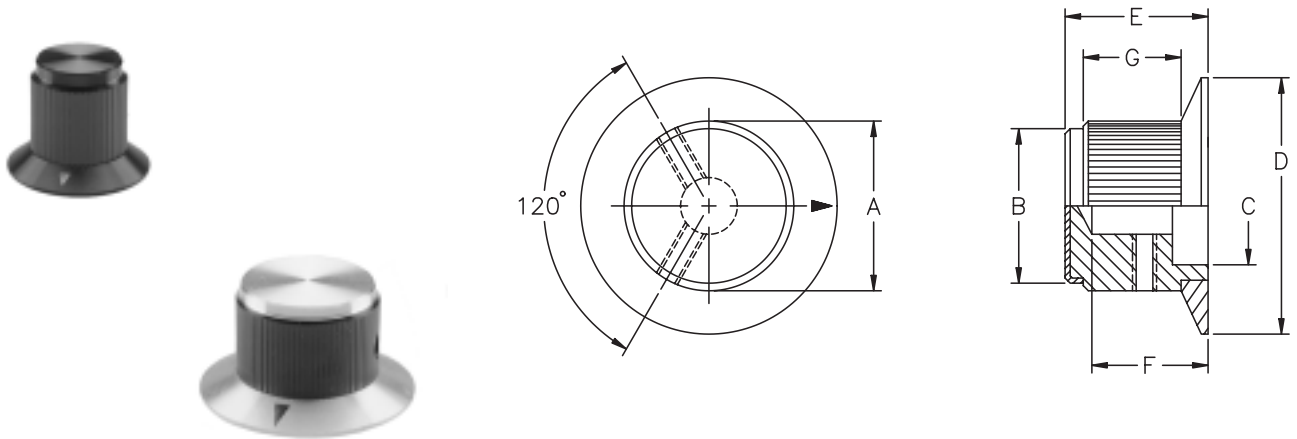

| MODEL | COLOR | A | B | C | D | E | F | G |
|------------------|-----------------------|-------------|-------------|-------------|-------------|-------------|-------------|-------------|
| KNS501A1/8 | Natural | .500 (12.7) | .450 (11.4) | .380 (9.65) | .750 (19.0) | .630 (16.0) | .510 (13.0) | .430 (10.9) |
| KNS501A1/4 | Natural | .500 (12.7) | .450 (11.4) | .380 (9.65) | .750 (19.0) | .630 (16.0) | .510 (13.0) | .430 (10.9) |
| KNS501B1/8 | Black | .500 (12.7) | .450 (11.4) | .380 (9.65) | .750 (19.0) | .630 (16.0) | .510 (13.0) | .430 (10.9) |
| KNS501B1/4 | Black | .500 (12.7) | .450 (11.4) | .380 (9.65) | .750 (19.0) | .630 (16.0) | .510 (13.0) | .430 (10.9) |
| KNS701A1/4 | Natural | .750 (19.0) | .700 (17.8) | .590 (14.9) | 1.13 (28.3) | .630 (16.0) | .510 (13.0) | .430 (10.9) |
| KNS701B1/4 | Black | .750 (19.0) | .700 (17.8) | .590 (14.9) | 1.13 (28.3) | .630 (16.0) | .510 (13.0) | .430 (10.9) |
| TWO-TONED | BODY-TOP-SKIRT | | | | | | | |
| KNS501BA1/8 | Blk. & Natural | .500 (12.7) | .450 (11.4) | .380 (9.65) | .750 (19.0) | .630 (16.0) | .510 (13.0) | .430 (10.9) |
| KNS501BA1/4 | Blk. & Natural | .500 (12.7) | .450 (11.4) | .380 (9.65) | .750 (19.0) | .630 (16.0) | .510 (13.0) | .430 (10.9) |
| KNS701BA1/8 | Blk. & Natural | .750 (19.0) | .700 (17.8) | .590 (14.9) | 1.13 (28.3) | .630 (16.0) | .510 (13.0) | .430 (10.9) |
| KNS701BA1/4 | Blk. & Natural | .750 (19.0) | .700 (17.8) | .590 (14.9) | 1.13 (28.3) | .630 (16.0) | .510 (13.0) | .430 (10.9) |



Notes: Dims. in inches & (millimeters). Shaft size is last 3 digits of Model No.

KS SERIES Solid aluminum with 3 flute design and line indicator on side and skirt

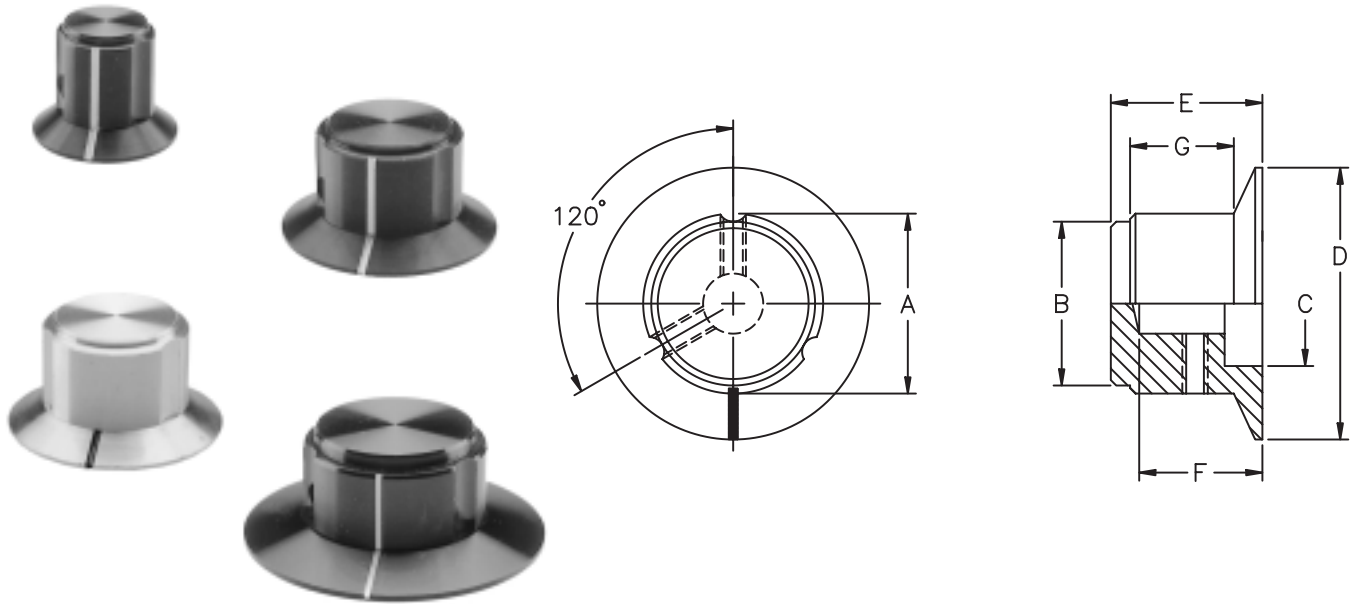

| MODEL | COLOR | A | B | C | D | E | F | G |
|-----------|---------|-------------|-------------|-------------|-------------|-------------|-------------|-------------|
| KS500A1/8 | Natural | .500 (12.7) | .430 (10.9) | .380 (9.65) | .750 (19.0) | .630 (16.0) | .510 (12.9) | .430 (10.9) |
| KS500A1/4 | Natural | .500 (12.7) | .430 (10.9) | .380 (9.65) | .750 (19.0) | .630 (16.0) | .510 (12.9) | .430 (10.9) |
| KS500B1/8 | Black | .500 (12.7) | .430 (10.9) | .380 (9.65) | .750 (19.0) | .630 (16.0) | .510 (12.9) | .430 (10.9) |
| KS500B1/4 | Black | .500 (12.7) | .430 (10.9) | .380 (9.65) | .750 (19.0) | .630 (16.0) | .510 (12.9) | .430 (10.9) |
| KS700A1/4 | Natural | .750 (19.0) | .650 (16.5) | .590 (14.9) | 1.12 (28.4) | .630 (16.0) | .510 (12.9) | .430 (10.9) |
| KS700B1/4 | Black | .750 (19.0) | .650 (16.5) | .590 (14.9) | 1.12 (28.4) | .630 (16.0) | .510 (12.9) | .430 (10.9) |
| KS900A1/4 | Natural | .940 (23.9) | .820 (20.8) | .710 (18.0) | 1.40 (35.6) | .630 (16.0) | .510 (12.9) | .430 (10.9) |
| KS900B1/4 | Black | .940 (23.9) | .820 (20.8) | .710 (18.0) | 1.40 (35.6) | .630 (16.0) | .510 (12.9) | .430 (10.9) |

SPECIFICATIONS SUBJECT TO CHANGE WITHOUT NOTICE.